

**POLYESTER
CAPACITOR
(GREENCAP)**

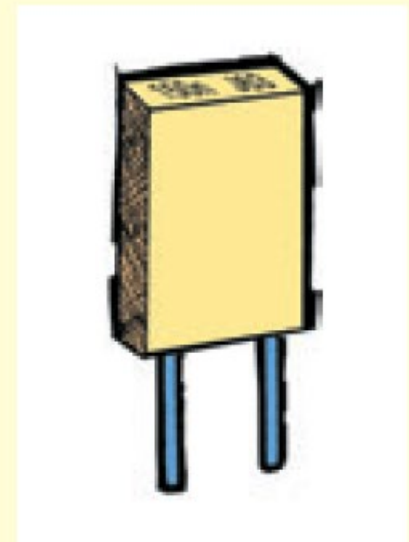

**MKT POLYESTER
CAPACITOR**



**CERAMIC
CAPACITOR**

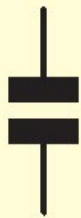

**ELECTROLYTIC
CAPACITOR**

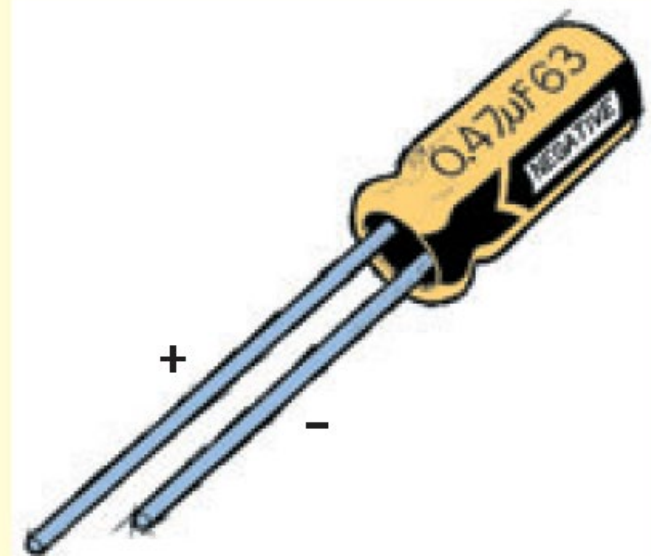

VARIABLE AND TRIMMER CAPACITORS



VARIABLES

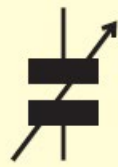

TRIMMER

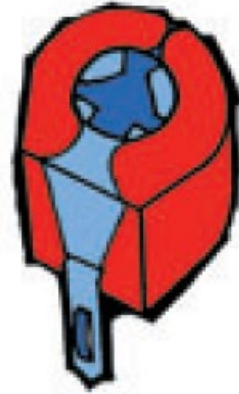

NPN TRANSISTOR
(PN100, BC548)

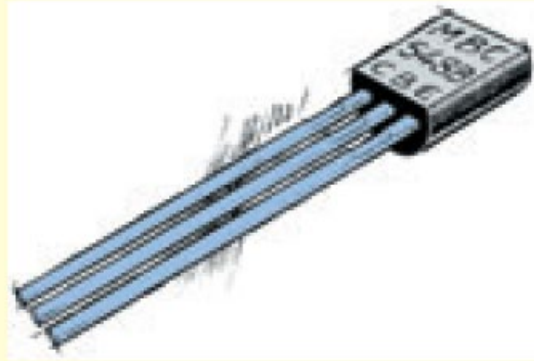
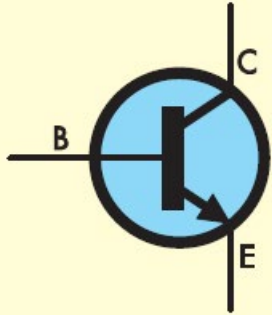

PNP TRANSISTOR
(PN200, BC558)

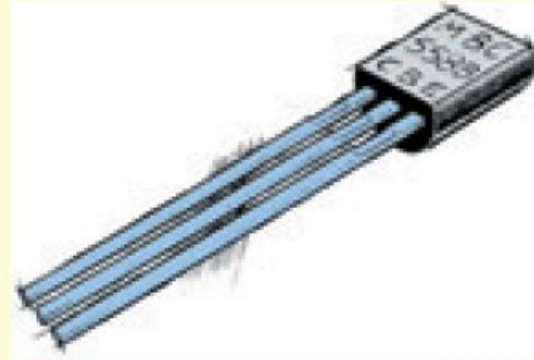
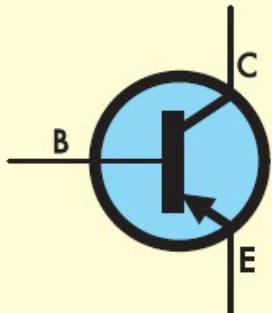

POWER TRANSISTOR
(NPN OR PNP)

(Same symbols
as above)



SILICON DIODE

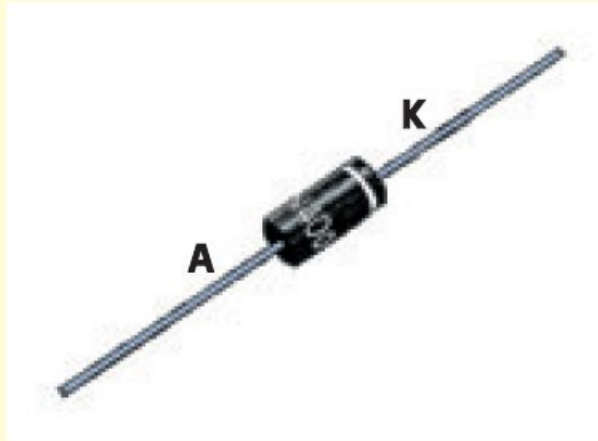

LIGHT EMITTING DIODE (LED)

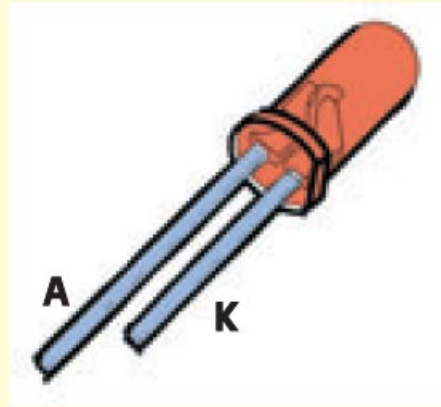

ZENER DIODE

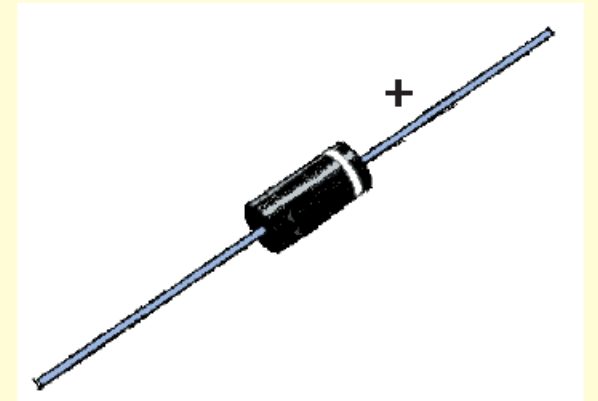

LED DISPLAY

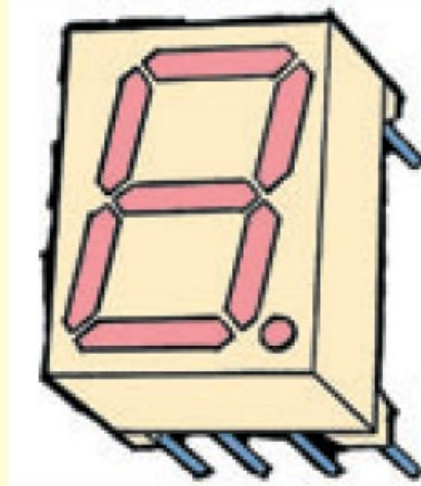
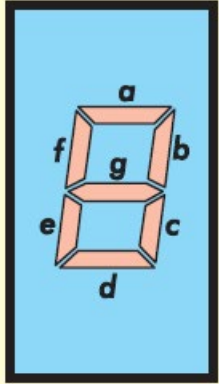

FET — JUNCTION TYPE

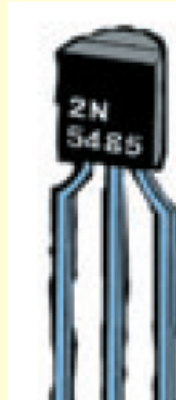
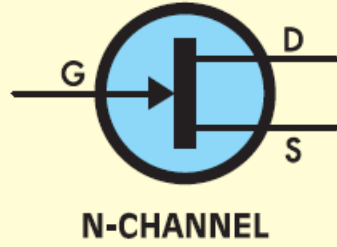

MOSFET — POWER TYPE

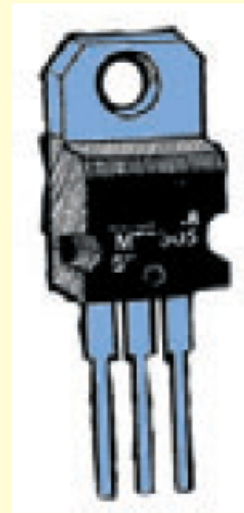

INTEGRATED CIRCUIT (IC)

(ICs have many symbols,
usually depicting their
function or circuit use)

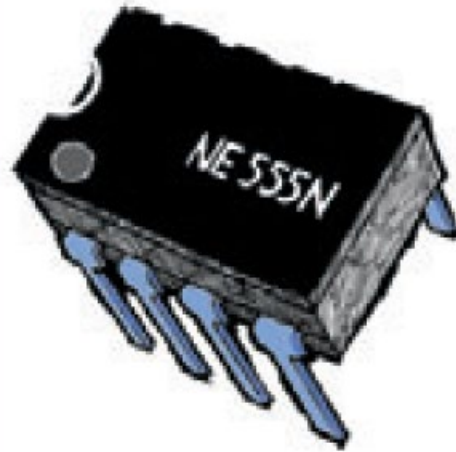

3-TERMINAL REGULATOR

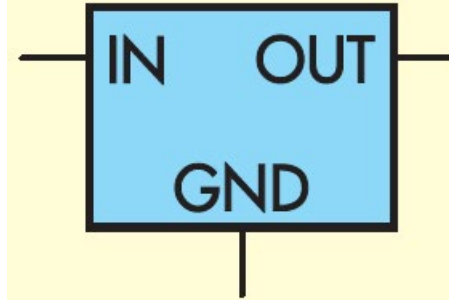

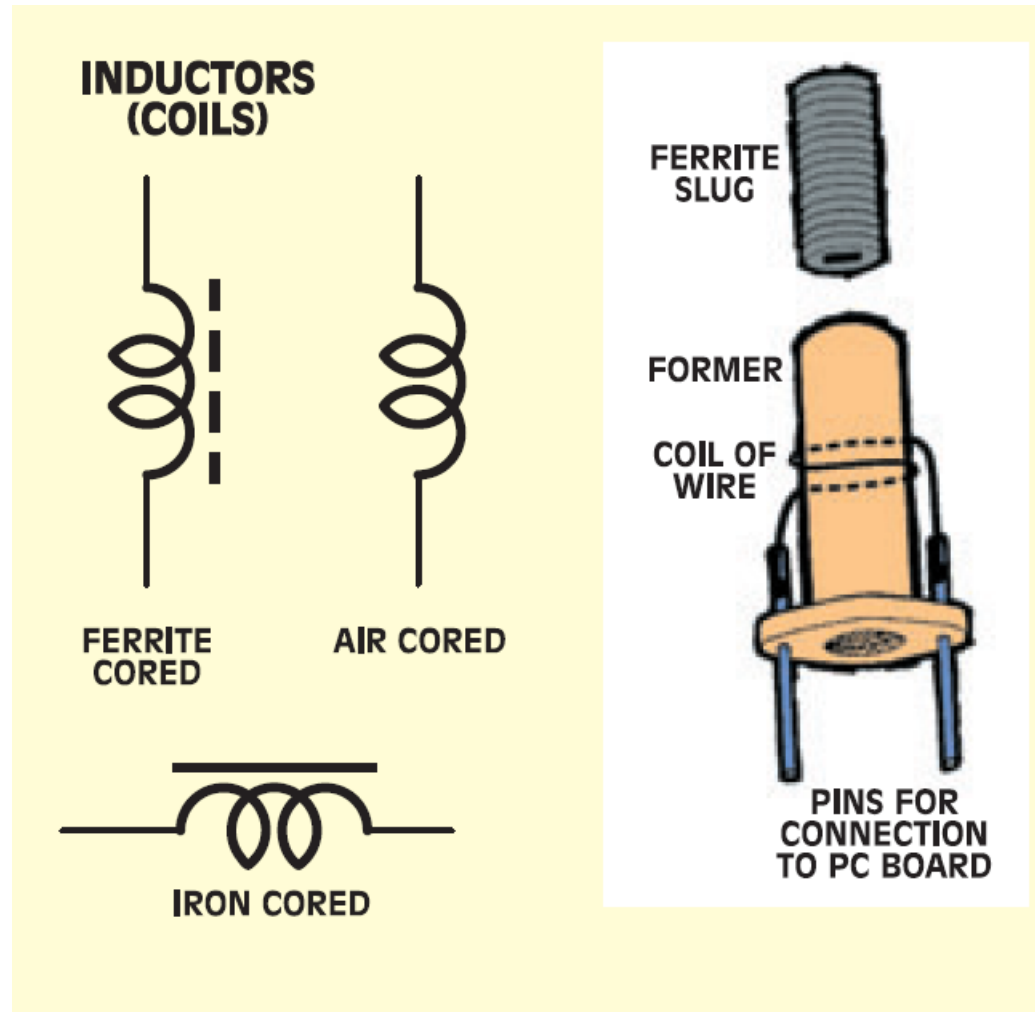

TRANSFORMER

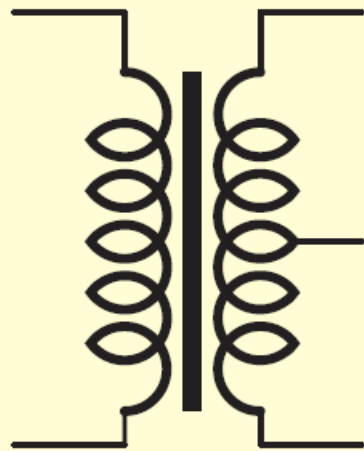

(IRON CORED)

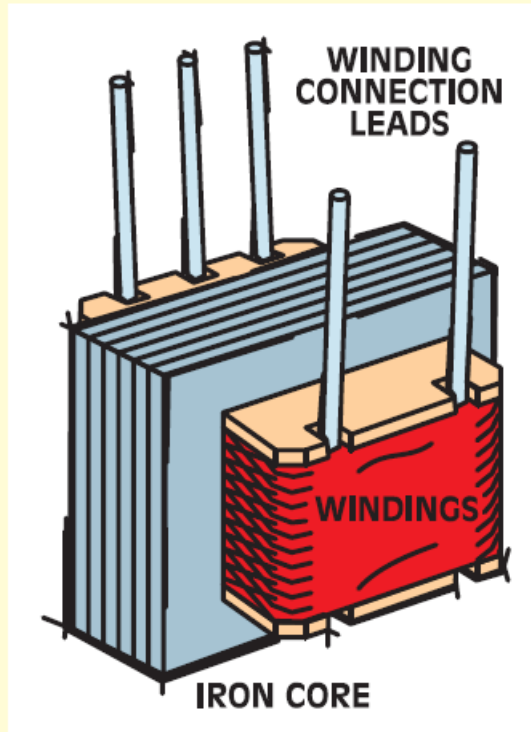

HEATSINK

(No circuit symbol)

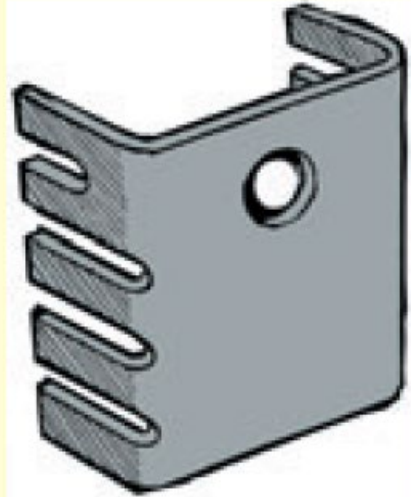

ELECTRET MICROPHONE

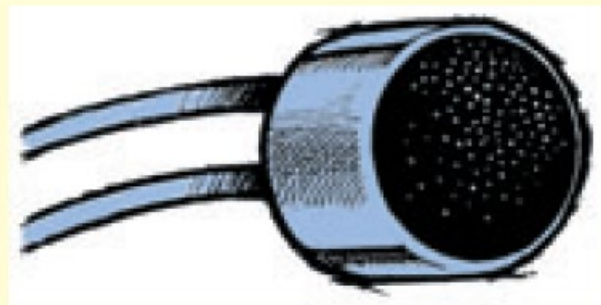

LOUDSPEAKERS

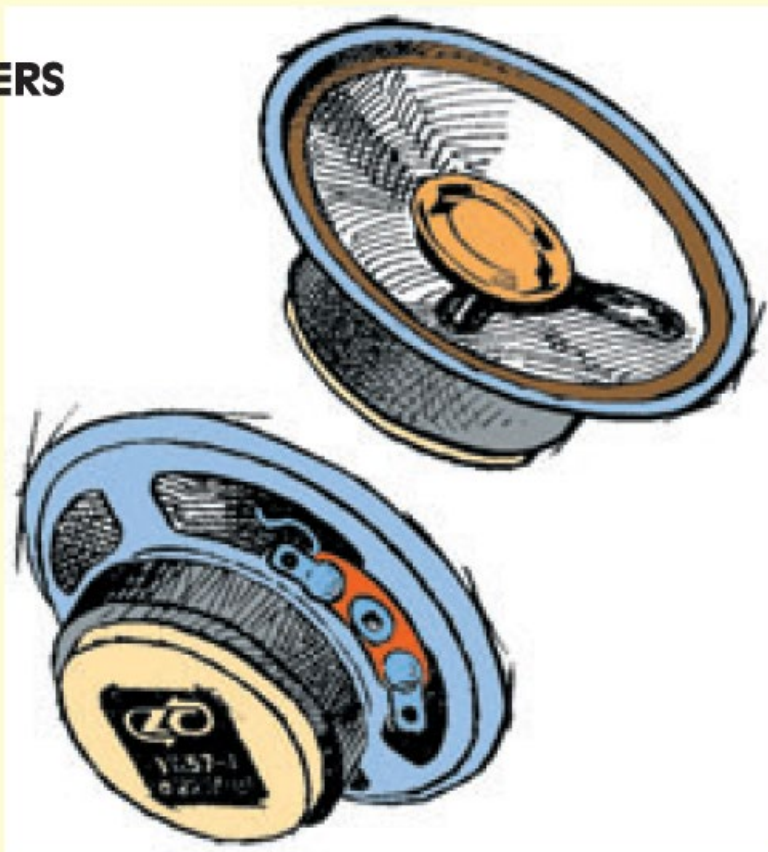

RELAY

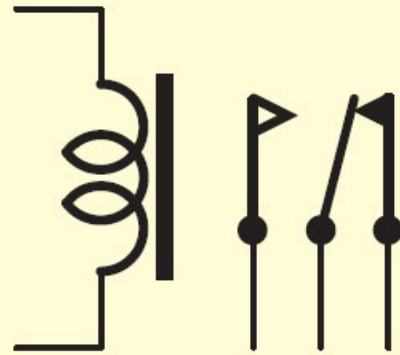

SWITCH – SLIDER

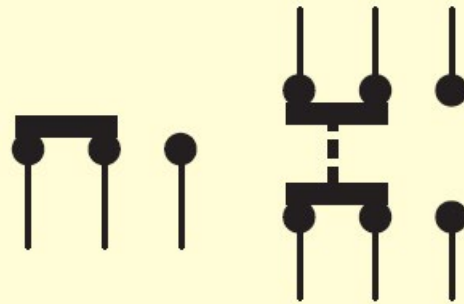

SPDT

DPDT

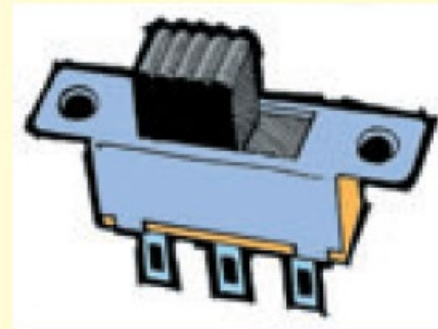

OFFICIAL

OFFICIAL